



Static Decay Analyzer

ETS Model 4406 Operating Manual

Table of Contents

I. Important Safety Information.....	3
II. Description of Contents	4
III. Set-Up Guide	5
IV. Quick Start Guide	8
V. Functionality	12
VI. Operating Instructions	14
A. Initial Turn-On & Verification.....	14
B. Sample Testing	17
C. Testing Hints	24
IX. Maintenance & Calibration	27
X. Warranty	30
APPENDIX A – Static Decay Procedure - Method 4046.1	31
APPENDIX B – NFPA Code 99	34
APPENDIX C - MIL-PRF-81705D.....	35
APPENDIX D - 4406 Controls and Connections	36
APPENDIX E - Electrode Configurations.....	43

Revision History:

Revision A: Released 2018-09-10 Reorganization and appearance update

Revision B: Released 2018-11-20. Added control and connections Appendix D

Revision C: 2019-04-09. Correct nominal decay range, page 14.

Revision D: 2020-11-12. Update RH requirements, update address.

Products described in this manual are designed and assembled in the U.S.A. by

Electro-Tech Systems, Inc.

700 West Park Avenue

Perkasie, PA 19844

I. Important Safety Information

SAFETY INSTRUCTIONS

The equipment described in this Manual is designed and manufactured to operate within defined design limits. Any misuse may result in electric shock or fire. To prevent the equipment from being damaged, the following rules should be observed for installation, use and maintenance. **Read the following safety instructions before operating the instrument.**

POWER

POWER CORD: Use only the power cord specified for this equipment and certified for the country of use. If the power (mains) plug is replaced, follow the wiring connections specified for the country of use. When installing or removing the power plug, **hold the plug, not the cord.**

The power cord provided is equipped with a **3-prong grounded plug (a plug with a third grounding pin)**. This is both a safety feature to avoid electrical shock and a requirement for correct equipment operation. If the outlet to be used does not accommodate the 3-prong plug, either change the outlet or use a grounding adapter.

FUSES: Replace fuses only with those having the required current rating, voltage and specified type such as normal blow, time delay, etc. **DO NOT** use makeshift fuses or short the fuse holder. This could cause a shock or fire hazard or severely damage the instrument.

OPERATION

CAUTION! DO NOT TOUCH OR COME IN CONTACT WITH THE EQUIPMENT WHILE IN USE.

Voltages used in the equipment may cause serious discomfort, injury, or death. ESD testing, by definition, involves hazardous voltage and unenclosed wiring. Power down and discharge all circuitry before contact.

DO NOT OPERATE WITH COVERS OR PANELS REMOVED. Voltages inside the equipment consist of line (mains) that can be anywhere from 100-240VAC.

DO NOT OPERATE IN THE PRESENCE OF A PACEMAKER OR OTHER MEDICAL OR LIFE-SUSTAINING ELECTRONICS. The equipment produces high-voltage discharges which may cause malfunction of nearby electronic circuits.

DO NOT OPERATE WITH SUSPECTED EQUIPMENT FAILURES. If any odor or smoke becomes apparent turn off the equipment and unplug it immediately. Failure to do so may result in electrical shock, fire or permanent damage to the equipment. Contact the factory for further instructions.

DO NOT OPERATE IN AN EXPLOSIVE ATMOSPHERE: Operating the equipment in the presence of flammable gases or fumes **constitutes a definite safety hazard**. For equipment designed to operate in such environments the proper safety devices must be used such as dry air or inert gas purge, intrinsically safe barriers and/or explosion-proof enclosures.

DO NOT USE IN ANY MANNER NOT SPECIFIED OR APPROVED BY THE MANUFACTURER: Unapproved use may result in damage to the equipment or present an electrical shock or fire hazard.

II. Description of Contents

Included in the standard Model 4406 package:

Item	Qty.	Description
Control Unit	1	Control unit houses the primary control and operating systems to provide high voltage, relay signals and sensor analysis.
Faraday Cage	1	Cage provides the means to test various samples.
Sensor (Model # 406-104)	1	The Model 4406 includes one sensor as standard system.
System Test Module (Model # STM-2)	1	STM-2 provides the means to verify that the system is in balanced before actual testing is performed.
Magnets	2	A pair of magnets are used to hold standard size sample to the base electrodes in Faraday cage.
Clamp Electrodes	2	A pair of clamp electrodes are used to hold non-standard size sample to the base electrodes in Faraday cage.
Brass Thumb Nuts	4	Are used to secure clamp electrodes on base electrodes.
Power Cord	1	AC line cord for connecting the control unit to power.
Communication Cable	1	9-pin DIN F-F RS-232 cable is used connect the system to a host PC.

III. Set-Up Guide

Diagram of Operating System Cables

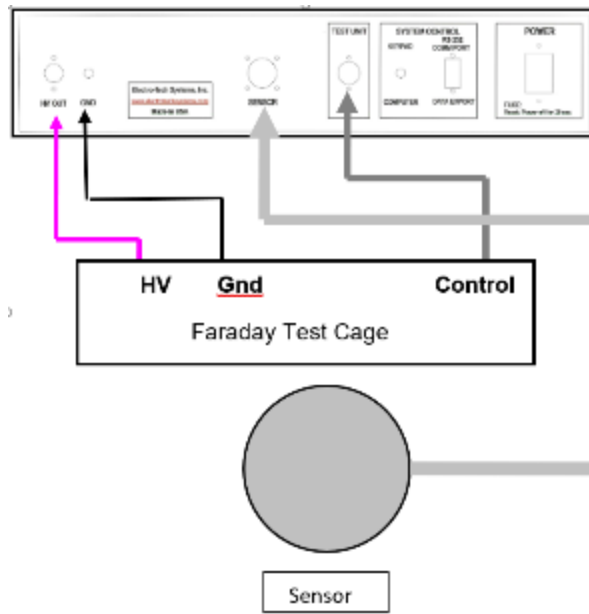

Preparation.

Select a location with controllable temperature and humidity. Select a level, sturdy work surface.

Note: For consistent results, maintain consistent temperature and humidity. For accurate results, humidity must be 50% or less. Measurements taken at 55% RH or above will not be valid.



Step 1 – With AC power DISCONNECTED, Connect High Voltage Cable

Make sure Power Switch on Control Unit's front panel is in OFF position before inserting connectors.

Connect the High Voltage Cable from the Faraday Cage to the Control Unit.

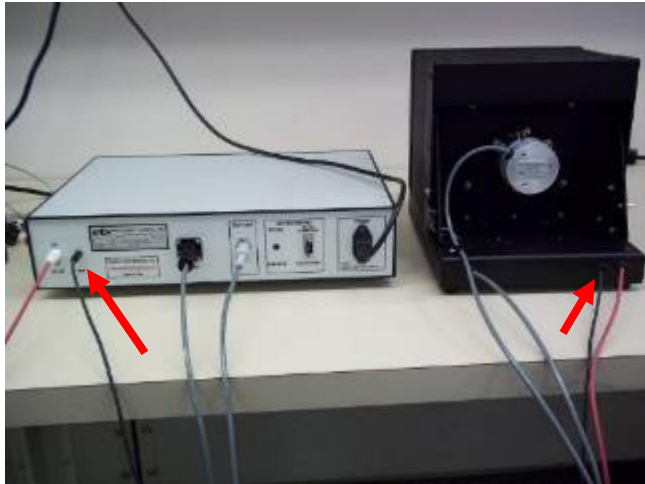

Step 2 – Connect Ground Cable

Connect the black ground cable from the Faraday Cage to the Control Unit.

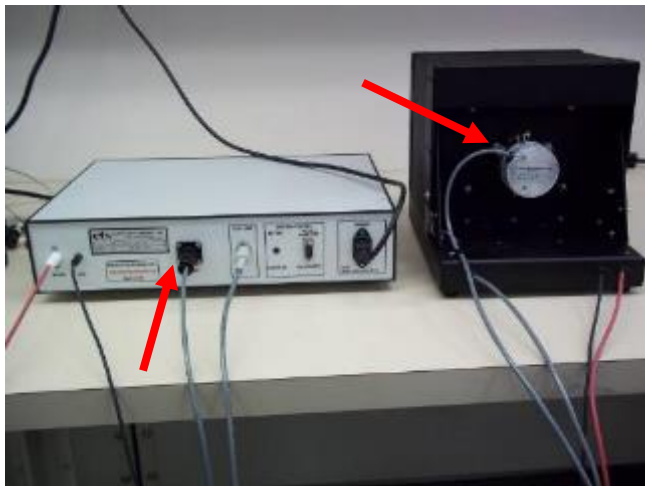

Step 3 – Connect Sensor Cable

Connect the grey sensor cable from the Faraday Cage to the Control Unit.

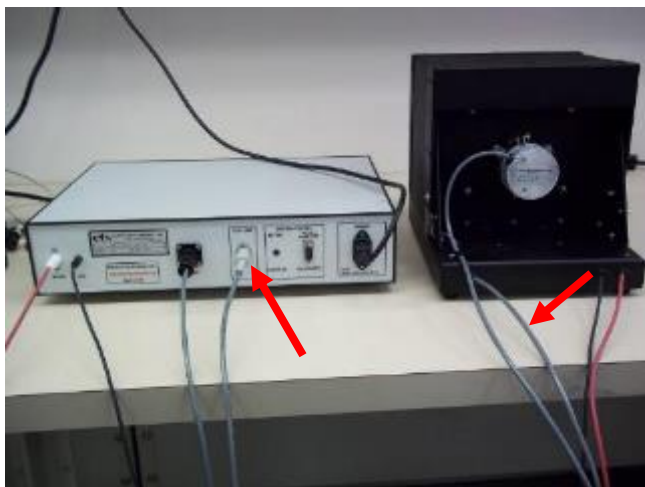

Step 4 - Connect Test Unit Cable

Connect the Test Unit Cable from the Faraday Cage to the Control Unit.



Step 5 - Connect Power Cable

Make sure Power Switch on Control Unit's front panel is in OFF position.

Connect the Power Cable to the back of the Control Unit.

Connect the Control Unit to the AC line by plugging its AC cord into a properly grounded AC outlet (Mains). The Power Cable may be plugged into any compatible outlet receptacle with 90-260 volts, 50-60 Hz.

IV. Quick Start Guide



Step 1 – Switch Power ON

Verify the system is set up as described in Section III, then Turn on POWER and allow the system to warm up for at least 5 minutes prior to testing. (If the Analyzer is to be used on an ongoing basis it can remain powered-up, but should be placed in the **ZERO/STBY** mode.)

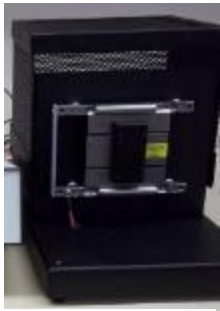

Open Cage

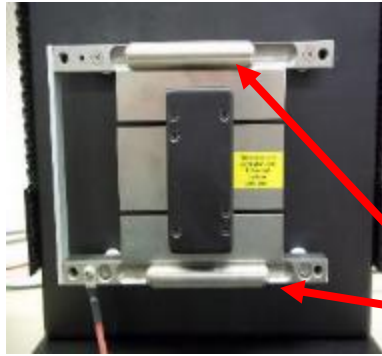

(Close-up view)

Step 2 – Open Faraday Cage cover and install STM-2 module as shown

Use the pair of rod-shaped Magnets to hold the STM-M module in place.



Step 3 – Close Faraday cage cover as shown.



Step 4 – Press “SYSTEM TEST” to run balance tests

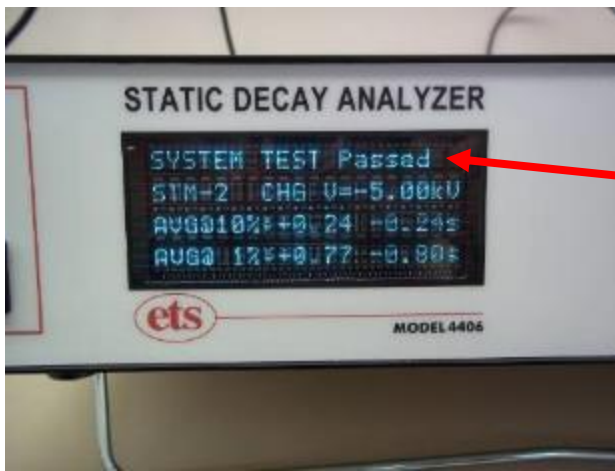

Step 5 – Wait until “SYSTEM TEST” shows “PASSED”



Step 6 – Open Faraday Cage cover and remove STM-2.

Remove the pair of rod-shaped Magnets holding the STM-M module in place. Be careful to avoid allowing the STM-2 to fall when removing the 2nd Magnet to avoid damage.



Step 7 – Install test sample, then close Faraday cage cover

After removing the STM-2, use either the Magnets or Clamp Electrodes to secure the test sample.



Step 8 – Press “MAN/AUTO” to go to AUTO mode

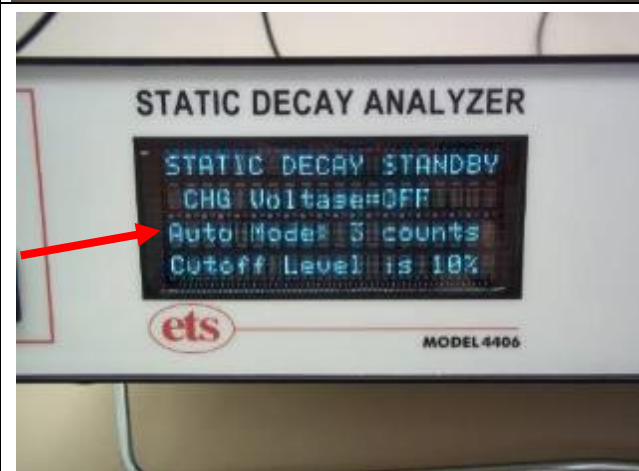

Step 9 – Make sure display shows AUTO mode



Step 10 – Press “DECAY TEST” to start AUTO tests

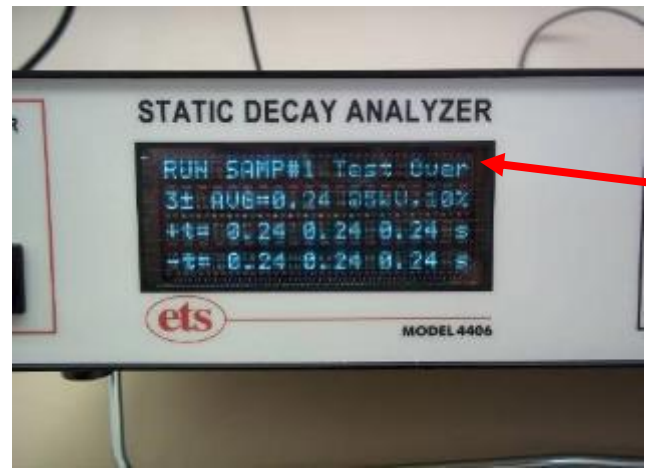

Step 11 – Wait for “TEST OVER. Record data then repeat steps 7-10 for next sample, etc.

V. Functionality

OVERVIEW:

The ETS Model 4406 Static Decay Meter, which replaced the previous generation Model 406, meets the requirements for static charge dissipation and static decay rate testing as required by DOD, NFPA, ESDA, INDA, EIA, CECC and other North American, European Union and Asian test specifications. A variety of electrode configurations are available which enable the static dissipative characteristics of film, fabric, foam, powder, loose fill, plastic, glass, paper, liners, formed parts (non-flat), nonwovens, bags, mats, cellulose, carriers, tote boxes, dispensing equipment, garments, tables, consumer products, seating, flooring and many other materials to be evaluated for electrostatic characterization.

The Model 4406 can be used for static decay analysis in R&D (Research & Development), QC (Quality Control) and other applications to test materials where static electricity can impact performance, production, manufacturing, handling, appearance, safety, and personal comfort.

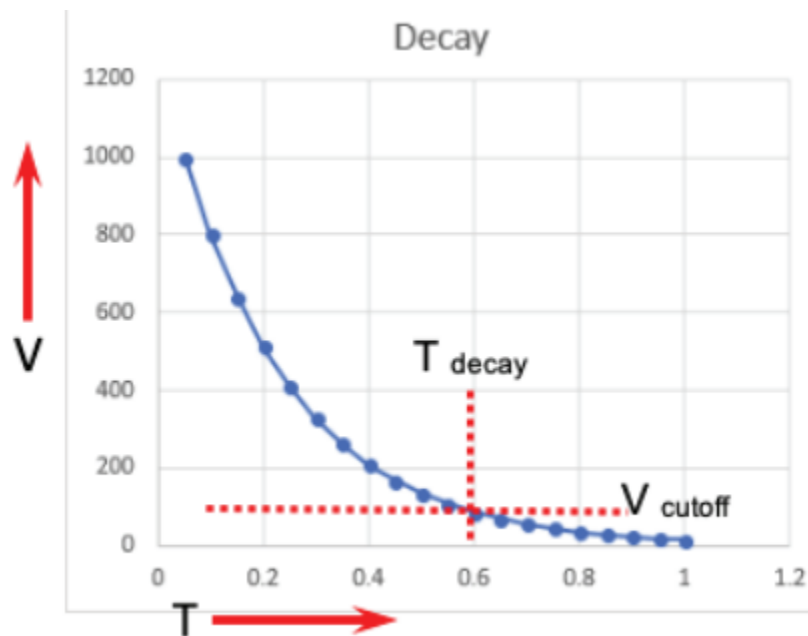

FEATURES

- Measure the static decay rate of static dissipative material for ESD safe applications
- Meets requirements of Method 4046, MIL-PRF-81705E (plus all previous generations), ANSI/ESD S541, NFPA 99 & 77, INDA, CECC, EU, SAE, ESD Association, Company Generated and other ESD (electrostatic discharge) test methods.
- Microprocessor based operation
- 0.001 second decay time resolution
- Automatic and manual test modes
- Variable cutoff levels
- System test module for verifying system operation
- Data output for computer capture
- Optional electrode configurations
- Optional environmental chambers

SPECIFICATIONS

CONTROL UNIT

Charging Voltage: Programmable +600 to +5,250V or -600 to -5,250V

Decay Window: 0.03, 9.99, or 99.9 sec, automatically selected

Decay Time Display: 3 digit digital

Decay Time Resolution: 0.1% of full scale

Cutoff Voltage Level: 1%, 10%, or Adjustable

Sensor:

Type: Electrostatic

Drift: <1% / min (Relative Humidity less than 50% RH)

Response time: 1ms (10-50% RH and 20 to 25 C)

Power:

Voltage: 90-260VAC, 50/60Hz; 0.75 Amps max

Input: IEC Socket with 6' (2m) cable with NA plug (Std)

Dimensions:

Size: 16-3/4"W x 12"D x 4"H (42.5 x 30.5 x 10 cm)

Weight: 8.5 lbs. (3.9kg)

FARADAY CAGE TEST FIXTURE

Required Environment (humidity):

50% RH or lower.

For best results, 50%RH or less is recommended

Sample Holder:

Magnetic: For Film, Fabric (included)

Clamp: For Non-flexible sheet (included)

Custom: For Shaped objects (available at extra cost)

Dimensions:

Size: 9-1/2"W x 11-1/2"D x 9-3/4"H (24 x 29 x 25 cm)

Weight: 9.5 lbs. (4.3 kg)

Warranty: One (1) Year – Parts & Labor

VI. Operating Instructions

A. Initial Turn-On & Verification

When turned on the system will default to **ZERO/STBY** status and the settings from any previous testing will be displayed as shown in Figure 5-1.

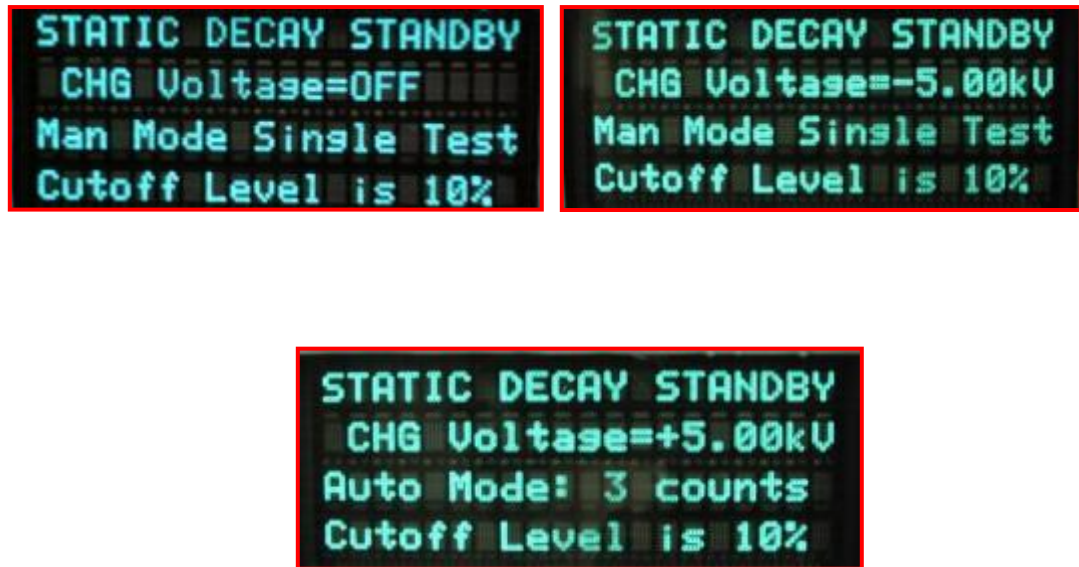

Figure 5-1: Typical **ZERO/STBY** displays at initial turn-on

At this time the Charging Voltage status, Test Mode and Cutoff level for sample testing can be set as follows:

- Select **MANUAL** or **AUTO** mode by depressing the **AUTO/MAN** key.
- Select desired **CUTOFF** level by depressing the appropriate key.

If the **ADJUSTABLE CUTOFF** is selected key in the desired cutoff (1-50%) then depress **ENTER**.

- Turn high voltage on by depressing the **HV ON/OFF** key. The red LED will light and the voltage displayed. To switch polarity, depress the **+/-** key. System defaults to +5.00kV.

If a voltage level other than 5,000V is desired it can be changed by depressing the **PROG V** key, key in the desired voltage using the 12-position keypad then depress **ENT**. In the **AUTO** mode the voltage is not adjustable.

d. Full Scale Calibration

Prior to testing it is necessary to check (or adjust) the full scale calibration of the electrostatic measurement. This is normally performed using the **STM-2** as follows:

Lift the hinged cover of the Faraday Cage and place the **STM-2** Module between the electrodes of the sample holder as shown in Figure 5-2. Return the cover to the operating position (cover down).

Depress the **CHARGE** key. The **CHG** Voltage reading on the display should read +5.00kV. The accepted charge on the **STM-2** should read **AC=5.00±0.30kV**. If not loosen the thumb screw locking the sensor in place and move it forward or back so both voltage readings are the same. Once this adjustment is made **DO NOT READJUST TO ACCOMMODATE THE SAMPLE UNDER TEST. ANY SMALL VARIATIONS ARE USUALLY CAUSED BY THE SHAPE AND/OR SIZE OF THE SAMPLE. A SIGNIFICANT DIFFERENCE IN READINGS IS USUALLY A RESULT OF MATERIAL CHARACTERISTICS.** Small variations are seen with samples that are non-planar such as bubble wrap or are concave or convex. The Analyzer will automatically take this variation into account when making a measurement as long as the indicated **AC=3.00kV** or more.

If small or non-conforming samples are normally being tested the Full Scale Adjust **MUST** be performed to accommodate this particular configuration. Make sure the sample being used for this purpose is conductive or static dissipative. If an actual sample is not available then use a conductive object similar in size. The indicated accepted voltage must be >3.00kV. If not contact ETS for technical assistance.

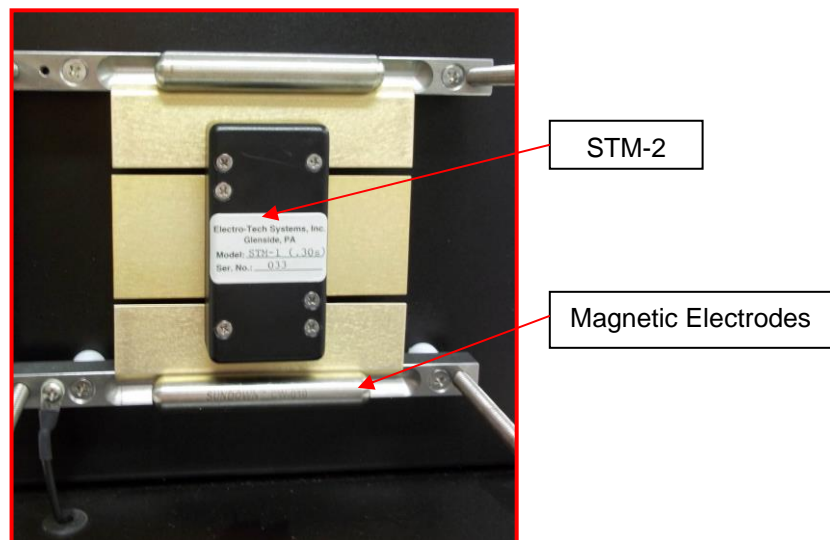

Figure 5-2: System Test Module in the Faraday Cage

NOTE: The unit employs a safety interlock system which prevents high voltages from being impressed on the test sample unless the Faraday Cage cover is positioned in the operate (cover down) position. Voltages up to ± 5000 Volts (current is limited to 50 microamps) are generated by the Control Unit and are transferred to the electrodes and subsequently to the test sample during normal operation. Caution should always be exercised when working with high voltage. **The recommended operating procedures should be adhered to all times. Further, no attempt should be made to modify the equipment or tamper with the interlock system in any way.**

e. System Check

This test should be performed using the **STM-2** prior to testing actual samples or once a day if testing is on-going.

The **DECAY TIME** reading should be within ± 0.05 seconds at 10% of the value indicated on the **STM-2 System Test Module** that typically has decay times between 0.18 and 0.30 seconds when held in place with the magnetic electrodes. Decay times to 1% are nominally 0.50-0.90 seconds. Clamp electrodes will usually result in a reading approximately 0.03 seconds lower due to the electrode effect described in Section 4.5. If the **DECAY TIME** reading is not within this tolerance, the unit may be out of calibration, or may not be functioning properly. The difference between + and - decay time readings should be no more than 0.02 seconds at 10% and 0.07 seconds at 1%. If this is the case, contact ETS for assistance.

To perform this test, depress the **SYSTEM CHECK** key. The system will automatically default to +5.00kV and perform an auto test with 3 measurements displayed at the time of measurement at +5.00kV at both 10 and 1% cutoffs and then repeated for -5.00kV. At the conclusion of the test cycle if the system is **balanced** (+ V and -V decay times similar) and the decay times are within tolerance as indicated on the **STM-2** the test sequence will display the average decay times at 1% and 10% cutoffs as shown in Figure 5-3.

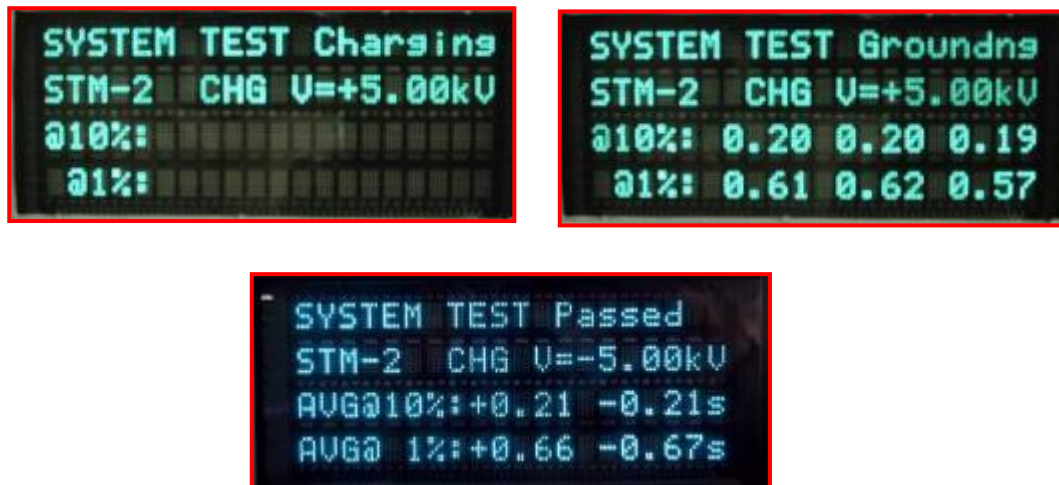

Figure 5-3: System Check using **STM-2**

If the system is **not** balanced, it will automatically try to rebalance and the display will read as shown in Figure 5-4.



Figure 5-4: Out of balance Auto Adjust

If the system does not auto balance and/or the timer runs on, the display will indicate **SYSTEM TEST Aborted** as shown in Figure 5-5.

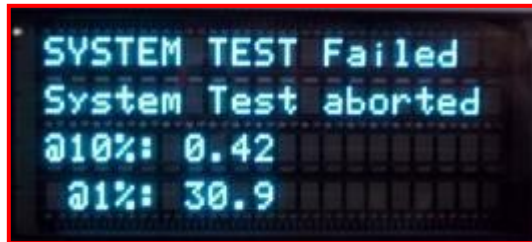

Figure 5-5: System fails Self Test

If this message is displayed, the Analyzer may need service or recalibration. Contact ETS at 215-887-2196.

B. Sample Testing

6.1. Sample Charge Characteristics - Standard 3.5"x5.5" (89x144mm) specimen size

Select **MAN**ual mode if not already done previously. Manual mode is recommended for samples with unknown static dissipation characteristics or a sample size significantly smaller than the standard size.

Magnetic electrodes are recommended for film and fabric samples and clamp electrodes for rigid or samples up to 1" (25mm) thick. For other optional electrode configurations, refer to Section VI.

When testing a sample with unknown static dissipation characteristics it is necessary that its basic characteristics be measured by observing the existence of an initial charge (**IC**) and its ability to

conduct on the charge applied to the electrodes. This analysis is performed by depressing the **CHARGE** key. Any charge detected on the surface of the sample will register as **IC=**. The Analyzer will then automatically check the ability of the sample to conduct charge across its surface by applying +5.00kV.

NOTE: Initial charge can be caused by the sample material not having any static dissipative characteristics, having hot spots where some portion(s) of the sample is insulative that has a charge inherent to the material, charge developed triboelectrically through handling and is detected by the electrostatic sensor. Also included are composite materials having insulated base material and conductive components to render the material static dissipative or conductive. An initial charge that is greater than the cutoff level will not enable a decay time measurement to be made.

When the **CHG** key is depressed one or more of the following events will occur:

- a. An Initial Charge is detected (**IC=**) as shown in Figure 6-1. When the charging voltage is applied for 60 seconds and **AC** is very low the sample is not able to conduct on a significant charge and, therefore, will not be able to dissipate charge when grounded. The sample can also have **IC=0**, and still not have any static dissipative characteristics.



Figure 6-1: Sample with and without **IC** and very low **AC**

- b. If the sample does accept at least 250V/sec after the charging voltage is applied, it will continue to be charged for 60 seconds at which time the amount of charge accepted due to the applied charge will be displayed as **AC=**. If the sample does not increase after the 5.00kV has been applied the test will be aborted and the display will read "**Sample won't charge**" as shown in Figure 6-2. A material with these characteristics is generally very insulative and any field detected is charge residing on the surface of the sample.

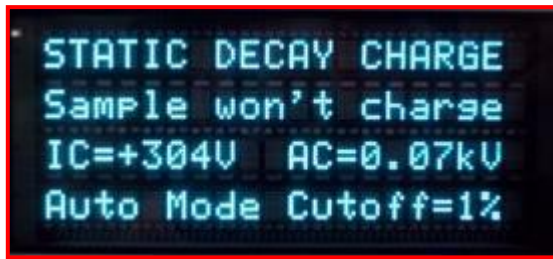

Figure 6-2: Display for a sample that won't charge

If the sample has some limited static dissipative characteristics the accepted charge after applying +5.00V for 60 seconds is displayed. The more static dissipative the material the greater the amount of charge accepted. This measurement is very helpful when trying to evaluate materials with antistat additive levels that are just beginning make the material static dissipative.

Even with an Initial Charge (**IC=0**) as shown in Figure 6-3 when the charging voltage is applied for 60 seconds and **AC** is detected the sample is able to conduct on some charge and, therefore, would be considered more dissipative than a sample that accepted a lesser charge.

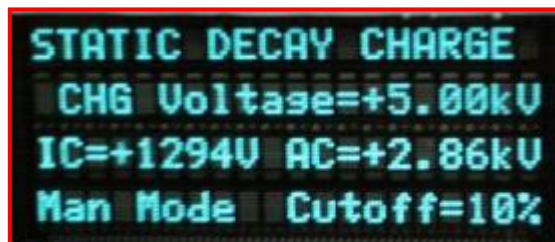

Figure 6-3: Sample with **IC** and **AC**

- c. No Initial Charge is detected (**IC=0V**) as shown in Figure 5-9. When the charging voltage is applied, over 3.00kV has been indicated to be accepted. In this case it was accepted very quickly and stabilized after 5 seconds. This type of sample was able to conduct on a charge and, therefore, would be capable of dissipating charge when grounded as shown in Figure 6-4. This example is that of a “dog bone” test sample with conductive material that indicates a fully accepted charge of 3.74 kV. The second display is for a sample that also exhibits static dissipative characteristic, but was a full size sample.

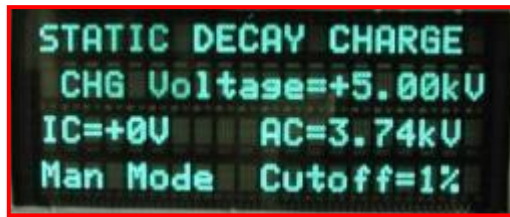

Figure 6-4: Sample with no IC and able to conduct charge

- d. A composite or laminated material will exhibit similar characteristics, but the apparent accepted charge will be more like 3.50-4.75kV. If a decay time measurement is attempted the time will actually be the collapse of the field yielding a very fast decay time measurement, usually <0.005 seconds (this decay time is approximately the fastest the Analyzer can measure and is a function of the time for the high voltage relays to switch). However, for composite and laminated materials the field collapse may not cross the cutoff threshold (usually 1%) and, therefore, decay time cannot be measured.

A decay time measurement will determine if the material is indeed static dissipative per the respective specifications.

The charging voltage can be applied for a maximum of 60 seconds at which time the measurement stops and the display stays in **CHARGE** for observation until reset.

If the sample has some limited static dissipative characteristics the accepted charge after applying 5.00kV for 60 seconds is displayed. The more static dissipative the material the greater the amount of charge accepted. This measurement is very helpful when trying to evaluate materials with different levels of antistat additives.

If the initial charge is less than the cutoff level and the sample accepts the full 5.00kV within 60 seconds then it should be possible to perform a decay time test.

Refer to Section VI for additional information.

Table 6.1 lists the **CUTOFF** levels required for the most common test specifications.

CUTOFF THRESHOLD	CUTOFF VOLTAGE*	APPLICABLE SPECIFICATION
50%	2500	Half Life
10%	500	NFPA Code 99
5%	50	CECC 00015 (1000V)
1%	50	Mil-PRF-81705C, EIA & ESDA 541

Table 6.1 Cutoff Levels and Applicable Specifications

*Nominal value. Actual cutoff is the percentage selected by the **CUTOFF** level selected. Example: If accepted voltage is 4.5kV, cutoff is 450V.

e. Decay Test

MANual mode: Depress the **DECAY TEST** key. The electrostatic sensor shutter will close momentarily (an audible click should be heard) then open to start the decay time measurement. The sample will charge until the full applied voltage is reached and stabilized for 5 seconds. (**Note:** The accepted charge indicated on undersize samples is displayed as a voltage less than the calibrated Full Scale calibration. This is a function of the electrostatic field viewed by the sensor. However, the measured decay time would still be the correct percentage of the selected cutoff level of 1 or 10%.) Each time the key is depressed a decay time measurement will be taken and displayed.

Depress the **+/-** key to reverse polarity and repeat the test cycle. **NOTE:** Wait for **TEST OVER** to be displayed before depressing the **+/-** key

The decay time will always be displayed as 3 digits. If the decay time is <0.02 seconds it will be displayed as 3-digit resolution (EX: .005 sec). Between 0.02 and <10 seconds resolution will be 2 digits (Ex: 1.25 sec) and above 10 seconds resolution will be 1digit (Ex: 12.4 sec).

If the sample does not give an indicated charge of at least 3.00kV the display will read “**Sampl can’t reach FS**” as shown in Figure 6-5

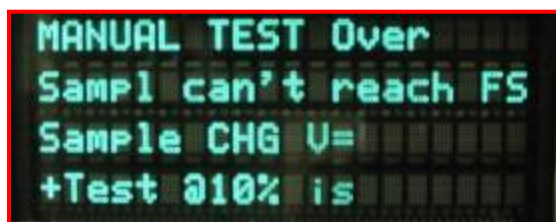

Figure 6-5: Sample not able to reach at least 3.00kV

To repeat or test a new sample, go to ZERO/STBY or depress the CHARGE or DECAY TEST key.

AUTO mode: Select the **AUTO** mode by depressing the **AUTO/MAN** key. Depress the **DECAY TEST** key to start an automatic static decay time measurement sequence. Up to 6 measurements at +V and then at -V can be programmed. Three (3) measurements at each polarity is the default setting. Both +V and -V decay times will be displayed on the same screen. If more than 3 measurements are taken all the +V measurements are first displayed then all the -V measurements. The average of the + and - decay times for the sample tested is displayed. Each time the key is depressed another decay time sequence (on the same or new sample) will be measured and displayed as shown in Figures 6-6 The test cycle always starts at +V.

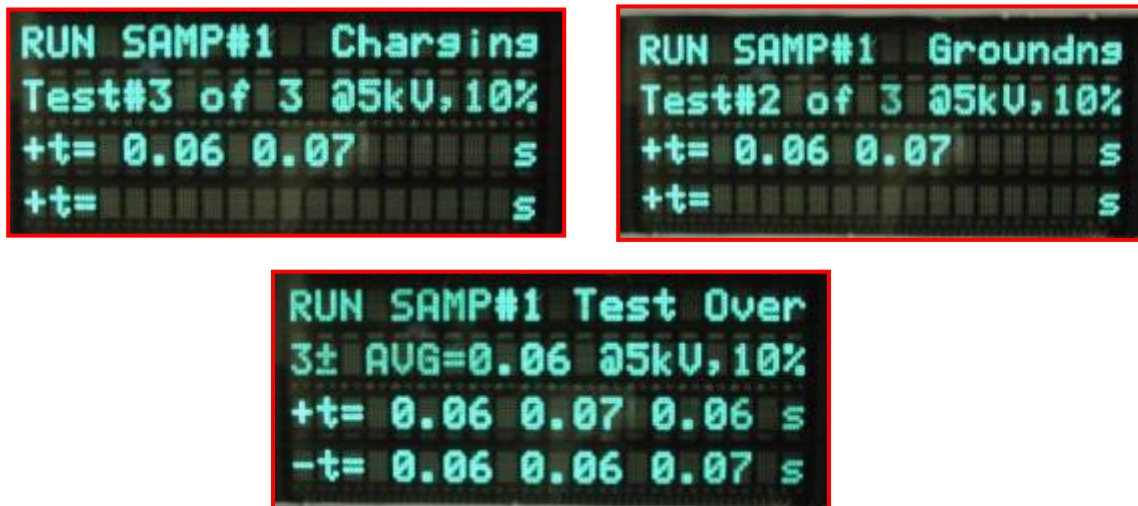

Figure 6-6: Auto mode decay test sequence display

To select the number of measurements to be taken select **ZERO/STDBY** then depress the **AUTO FUNC SET** key. The display will appear as in Figure 6-7. Key in the number of “counts” from 1 to 6, then depress the **ENT** key.

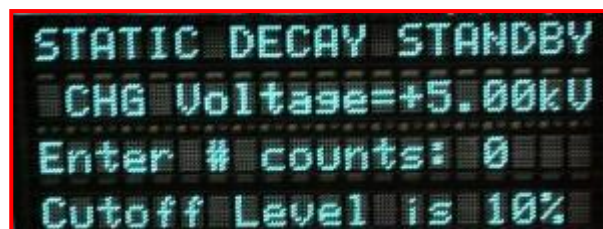

Figure 6-7: Programming # of counts

At the conclusion of testing a group of similar samples, depress the **DATA ANAL** key. The **Min**, **Max** and **Average** decay time of the sample group will be displayed as shown in Figure 6-8.

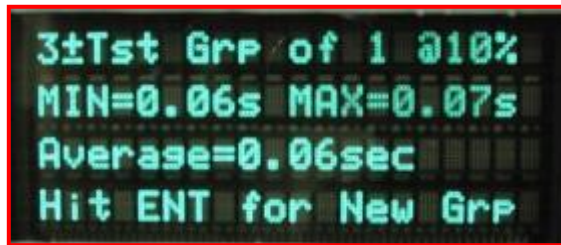

Figure 6-8: Auto mode group data analysis display

If the decay time exceeds 30 seconds the test is aborted and the display reads “**ABORT TESTS**” then after 2 seconds it will read “**RERUN IN MAN MODE**” as shown in Figure 6-9.

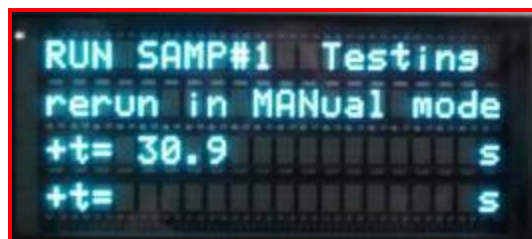

Figure 6-9: Display when decay time exceeds 30 sec.

A new group of samples begins if **ENTER** key is depressed in Data analysis screen as shown in Figure 6-10.

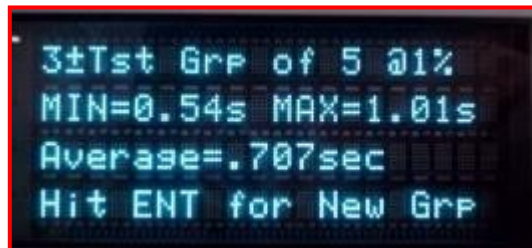

Figure 6-10: Display when new group can be entered
(Cutoff is changed or Auto count is changed)

NOTE: For additional information on sample testing, please refer to **Section VI "Testing Hints and Other Tests"**.

C. Testing Hints

8.1 General

The measurement of electrostatic charge is dependent on several factors, mainly sample characteristics, humidity, and to a much lesser extent, temperature. It is very common for a 10% change in one condition, such as humidity, to cause a significant change in decay rate. It is very important to try to duplicate a set of conditions exactly when attempting to compare measurements. Many times this is not possible, such as when an antistatic additive blooms to the surface of a material over a period of time. The following are some hints and additional test procedures that will help to understand the many factors affecting electrostatic measurements.

8.2 Free Air Measurement

Measure the electrostatic field with 5.00kV applied to just the electrodes (no sample in place). This is the free air electrostatic field caused by the charge on the electrodes. It is approximately 1,500-1,800 Volts with magnetic electrodes and 2,000-2,200 Volts with clamp electrodes. Other electrode configurations will result in different voltage levels.

If a sample is inserted the maximum charge measured when 5.00kV is applied is the free air value. This indicates that the sample is a very good insulator and will not accept any conducted charge. The Model 4406 automatically subtracts this value when measuring initial charge (**IC=**). Remember, these are electrostatic field measurements and the voltage displayed is the average value of the charge over the sensor's total viewing area.

The charging voltage is applied to the ends of the sample. If the sample has very high insulating properties the electrons will not flow across the sample. However, since the electrons will not flow, the material may have developed a deficiency or an excess of electrons during manufacture or by handling. This condition results in the material having an initial charge associated with it that will not change by conductive charging or by grounding. When the material is rubbed or separated, voltages may be generated by triboelectric charging. The only way to remove this initial charge is to place it in front of an ionizer for several seconds. This will remove the initial charge, but it will not alter its ability to conduct or dissipate charge.

8.3 Effects of Humidity

Chemically treated antistatic materials are dependent on the relative humidity for effectiveness. **The Model 4406 is designed for humidity levels 50% or less.** Maintain a consistent humidity level for testing.

Both topically treated and internally mixed antistatic materials draw moisture from the atmosphere to produce an electrostatically conductive layer on the surface. Antistatic chemical concentrations may be such that at a modest relative humidity of 50% the sample will exhibit excellent characteristics with very fast decay times (less than 0.1 seconds), but may not exhibit any static dissipative properties at 12% R.H.

Carbon or metal fiber loaded materials are not humidity dependent, but if the loading is too light then the effects of the filler material will be dependent upon humidity. Generally, these materials may be unstable due to changes in the dielectric that may occur during the charge cycle.

8.4 Insulative Materials

An insulative material (one defined as having a surface resistivity greater than or equal to 1×10^{12} ohms/sq.) does not permit electrons to flow easily across the surface. However, electrons can be removed or added triboelectrically to produce a positive or negative charge on the material. When this occurs, the sample is said to have an initial charge. This initial charge is detected during the **CHARGE** function as **IC=**. If the entire sample is insulative, then when 5.00kV is applied the sample will not conduct a charge and when the sample is grounded the sample will not bleed off the charge. When the 5.00kV is applied, the Accepted Charge (**AC=**) is the algebraic sum of the initial sample charge and the free air value described in Section 8.2. The Analyzer measures the indicated voltage on the sample for several microseconds prior to applying the 5.00kV and displays the value as **IC=**.

If only a portion of the sample is insulative, then **IC=** will read an initial charge (not a calibrated value, because the "hot" spot occupies only a portion of the field that is in view of the electrostatic sensor). When 5.00kV is applied, **AC=** will read the algebraic sum of the initial charge, **IC=** and the field emanating from the electrodes (nominally 1,500V with magnetic electrodes when 5.00kV is applied). When the **DECAY TEST** button is depressed, the sample will bleed off the applied charge and decay down to the initial charge. If this charge is greater than the cutoff level then the decay time cannot be measured. This evaluation can only be done in the **MANUAL** mode.

Marginally static dissipative materials with very long decay times, and therefore, very long charging times, are automatically evaluated by measuring the amount of charge the sample accepts after 60 seconds (**AC=**). The accepted charge in this case is the charge conducted across the sample after 5.00kV has been applied (initial charge plus free air value are subtracted from the **AC=** measurement after the sample has accepted at least 250V) for the 60 second time period. The more charge accepted within the established time period, the better the static dissipative characteristics of the material.

8.5 The Standard Exponential Decay Curve

The 4046 type test method actually has a minimum of 2 decay curves. The first is the collapse of the electrostatic field from the electrodes. The second is the decay of the charge on the surface of the sample. The electrode field is the free-air charge measured without any sample in the electrodes. Therefore, the exponential decay curve actually starts at approximately 3500V not from the applied 5000V.

When testing a sample, the charge on the sample bleeds through the electrodes to ground via the ground relay. The **STM-2** simulates an actual sample using a resistance of approximately 3×10^{10} Ohms and the system intrinsic capacitance. Since the electrode resistance is much lower than the sample or **STM-2** resistance, the decay time curve becomes the composite of at least two different exponential decays as shown by the dash line. The field on the electrodes collapses first

then the charge on the sample begins to bleed off to ground as shown in Figure VI-1. The intrinsic capacitance of the Faraday Test Cage, electrodes and discharge circuit is 50pF. The discharge circuit incorporates a 10 MegOhm resistor that limits the fastest decay time to 1% to 1.25 milliseconds. The relay switching time is approximately 3 milliseconds (0.003 sec). Samples with non-uniform antistatic treatment can have multiple exponential decay curves with the decay characteristics changing from the fastest decay time curve to the slowest decay time curve. Hence, static decay will always measure the least dissipative portion of the sample.

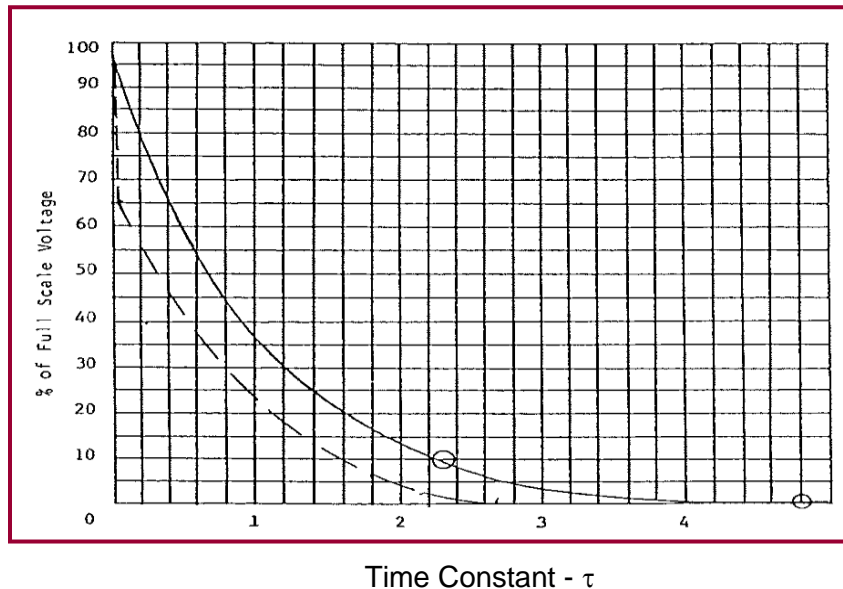

Figure 8-1: Standard and Method 4046 Exponential Decay Curves

8.6 Measuring Laminated Film

The Model 4406 is specifically designed to measure the static decay characteristics of homogeneous static dissipative material having a surface resistance between 10^8 and 10^{12} Ohms. Below 10^8 Ohms the decay time is less than the measurement capability of the instrument (minimum time is nominally 0.003 seconds). This is due to the time required for the internal relays to switch. Above 10^{12} Ohms, the time to charge the material ranges from several seconds to not being able to conduct the applied 5.00kV charge.

Laminated materials such as static shielding film may consist of two or more layers with one layer being conductive. This composite alters the way the static decay time is measured. **When testing this type of material, the edges must not touch the electrodes. The samples must be cut oversize (6"x6" [150x150mm]).** The following are different types of measurements observed when testing this material:

1. **Conductive layer facing sensor:** The conductive layer will become charged to the full 5kV and when grounded will decay almost instantly to 1% in <.01 sec.
2. **Dissipative or insulative layer facing sensor:** If this layer is dissipative it will charge to the full 5kV and when grounded will have a measurable decay time, usually in the millisecond range. If this layer is insulative the applied charge will be induced onto the surface of the conductive layer

and the accepted (**AC=**) will indicate an accepted charge that is slightly less than 5.00kV, typically, around 4.5-4.8kV. When grounded, the charge on the conductive layer collapses and the decay time drops instantly to some voltage slightly above the 1% cutoff level, typically, about 2-500V. In this case, the clock will continue to run. **Note:** The amount of accepted charge will decrease and the residual charge will increase as the insulated layer thickness increases.

3. **Triple laminate:** This material will perform in a similar manner as the dissipative or insulated side for the two-layer film described above.

IX. Maintenance & Calibration

The Model 4406 Static Decay Analyzer, like all precision electronic instruments, should be returned to the factory once a year for calibration. However, due to heavy use or having been moved to another location the instrument may require some minor adjustments in the interim. This section covers adjustment of **FULL SCALE**.

The **FULL SCALE** adjustment is performed externally by adjusting the distance between sensor and sample.

9.1 4406 Full Scale Adjustment

The Sensor Head spacing has been set at the factory for planar material and should not have to be re-adjusted under normal circumstances. Should it be necessary to reset the spacing of the sensor head, the procedure below should be followed:

1. Mount the **STM-2** System Test Module in the Faraday Cage. An actual conductive or dissipative sample can also be used.
2. Select the **MAN** mode and adjust the charging voltage to +5.00kV.
3. Depress the **CHARGE** key. The accepted charge (**AC=**) should read **+5.0±.3kV**. If not, loosen the Sensor Head retaining clamp screw and move the sensor forward to increase the **AC=** reading and conversely, rearward to decrease the **AC=** reading. Make certain the sensing portion in the Sensor Head is always in the 12 o'clock position and appears centered in the viewing hole in the Faraday Cage. Retighten the retaining clamp screw.

The full scale setting is critical for laminated material. If the full charge is conducted onto the material the **AC=** will display the fully applied 5.00kV. If the charge was induced onto the material, the **AC=** will indicate an accepted voltage level that is several hundred volts less, depending on the thickness of the material. When the decay time is measured, the decay time will drop very quickly due the collapse of the electrostatic field on the electrodes and the buried conductive layer leaving a small residual charge that remains on the non-conductive or dissipative outer layer. If this remaining charge is greater than the cut off level the clock will run on. However, if it is less than the cut off level the clock will indicate a very fast decay time (<0.005sec) If the outer layer is dissipative, the decay will drop rapidly then bleed off the remaining charge where the clock will indicate the decay time.

9.2 How to Zero Out Initial Charge

Reset Balance (Initial Charge) is set at the factory but if an adjustment becomes necessary, follow these steps:

1. Make sure STM-2 is installed before proceeding with the below instructions
2. Press "ZERO/STDBY" button to go to this screen.



3. Press and hold "ZERO/STDBY" button until "-" appears between STATIC and DECAY.

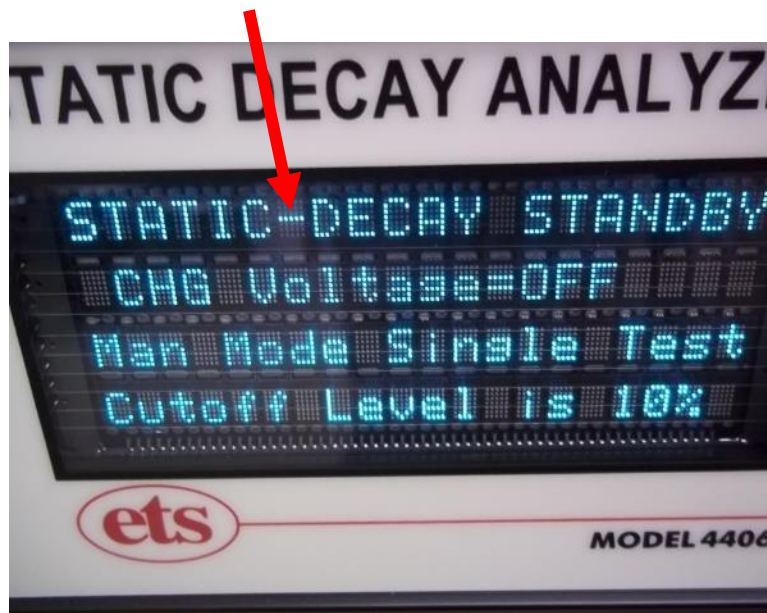

X. Warranty

Electro-Tech Systems, Inc. warrants its equipment, accessories and parts of its manufacture to be and remain free from defects in material and workmanship for a period of one (1) year from date of invoice. ETS will, at its discretion either replace or repair without charge, F.O.B. Glenside, similar equipment or a similar part to replace any equipment or part of its manufacture which, within the above stated time, is proved to have been defective at the time it was sold. All equipment claimed defective must be returned properly identified to the Seller (or presented to one of its agents for inspection). This warranty only applies to equipment operated in accordance with Seller's operating instructions.

Seller's warranty with respect to those parts of the equipment that are purchased from other manufacturers shall be subject only to that manufacturer's warranty.

The Seller's liability hereunder is expressly limited to repairing or replacing any parts of the equipment manufactured by the manufacturer and found to have been defective. The Seller shall not be liable for damage resulting or claimed to result from any cause whatsoever.

This warranty becomes null and void should the equipment, or any part thereof, be abused or modified by the customer or if used in any application other than that for which it was intended. This warranty to replace or repair is the only warranty, either expressed or implied or provided by law, and is in lieu of all other warranties. The Seller denies any other promise, guarantee, or warranty with respect to the equipment or accessories and, in particular, as to its or their suitability for the purposes of the buyer or its or their performance, either quantitatively or qualitatively or as to the products that it may produce. The buyer is expected to expressly waive rights to any warranty other than that stated herein.

ETS must be notified before any equipment is returned for repair. ETS will issue an RMA (Return Material Authorization) number for return of equipment.

Equipment should be shipped prepaid and insured in the original packaging. If the original packaging is not available, the equipment must be packed in a sufficiently large box (or boxes if applicable) of double wall construction with substantial packing around all sides. The RMA number, description of the problem along with the contact name and telephone number must be included in formal paperwork and enclosed with the instrument. Round trip freight and related charges are the owner's responsibility.

WARNING

UNITS ARE HEAVY AND CAN BE DAMAGED IN SHIPMENT. RETAIN ORIGINAL SHIPPING CONTAINERS FOR SHIPPING THE SYSTEM. OTHERWISE PROVIDE DOUBLE WALL PACKING WITH AT LEAST 3" OF FOAM BETWEEN LAYERS. DO NOT PLACE INSTRUMENTS OR ACCESSORIES INSIDE OTHER INSTRUMENTS OR CHAMBERS. ELECTRO-TECH SYSTEMS, INC. WILL NOT ASSUME RESPONSIBILITY FOR ADDITIONAL COST OF REPAIR DUE TO DAMAGE INCURRED DURING SHIPMENT AS A RESULT OF POOR PACKAGING.

APPENDIX A - Method 4046.1 - Electrostatic Properties of Materials

METHOD 4046.1 - FED. TEST METHOD STD. NO. 101C - October 8, 1982

NOTE: The Model 4406 was designed to implement Method 4046, and it remains the premier technology for performing this test. A Static Decay test is the most reliable way to test a material, since it actually charges the sample and measures how fast it bleeds off the charge. A resistance test is sometimes used as a substitute for Method 4046, but static resistance may only be part of the story for some materials.

1. SCOPE

1.1 This test is used to determine the electrostatic properties of materials in film and sheet form by measuring the intensity and polarity of an induced charge and the time required for complete dissipation of the induced charge.

1.2 This method does not determine the surface, volume or insulation resistivities of materials.

2. DEFINITION

2.1 Electrostatic properties are defined as the ability of a material, when grounded, to dissipate a charge induced on the surface of the material.

3. APPARATUS

3.1 A metal template, 5 by 3 by 1/8-inches.

3.2 A high voltage source, 0 to 15 KV, positive and negative.

3.3 An electrometer with a full-scale reading of 0.01, 0.1, 1.0, 10 and 100, or a recording oscilloscope with a response of 1 microsecond per division, or equivalent.

3.4 A fabricated electrostatic test chamber with electrostatic test unit, illustrated in figures 1 through 5.

3.5 A single channel computer data capture capability and RS232 connection cable..

3.6 Four s for connections between the detector and the electrometer, and between the electrometer and the recorder. The nominal lengths of the cables are:

- a. RG 114/U cable, 5 inches for the connections between the detector and the output connector on the electrostatic test chamber.

- b. RG 114/U cable, 34 inches between the electrostatic test chamber and the electrometer, exclusive of the connectors.

- c. RS232 cable, 6 feet between the electrometer and the computer

3.7 Three-position control switch for connecting the test specimen to the high voltage source or the ground or neutral potential.

3.8 The equipment shall be assembled as shown.

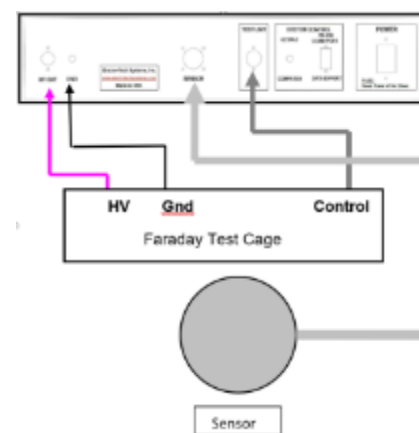

4. SPECIMENS

- 4.1 Select specimens at random and in sufficient number to represent adequately the variation of the material. A minimum of three specimens per condition per sample are required.
- 4.2 Each specimen shall be 5 by 3 inches and shall be free of defects such as holes, cracks and tears. If the specimen is coated, the coating shall be continuous.

5. CONDITIONING

- 5.1 Prior to testing, expose one-third of the specimens for 12 days in an oven uniformly maintained at $160^{\circ} \pm 5^{\circ}$ F; one-third of the specimens in a horizontal position for 24 hours under a continuous water shower; one-third of the specimens in an atmosphere uniformly maintained at $73^{\circ} \pm 5^{\circ}$ and 50 ± 5 percent relative humidity.
- 5.2 Unless otherwise specified, all specimens shall be placed in the electrostatic test chamber under conditions stated in 5.3 for a minimum of 24 hours immediately before testing, as specified in section 6.
- 5.3 Test environment. Perform tests in an atmosphere uniformly maintained at $73^{\circ} \pm 5^{\circ}$ F and of less than 15 percent relative humidity. This relative humidity can be obtained by inserting sufficient anhydrous calcium chloride into the electrostatic test chamber. The anhydrous calcium chloride shall be replaced as required to maintain required relative humidity.

6. Procedure

6.1 Calibration

- 6.1.1 Turn on all apparatus and allow to warm up, as noted in the operations manual for the particular apparatus.
- 6.1.2 On the electrometer, set "multiplier" switch to provide a half-scale reading when the test voltage is applied, the "operate" switch at "zero check" and the meter to read positive charge.
- 6.1.3 Adjust the high voltage for 5 KV positive output.
- 6.1.4 Mount a 1/8- by 3- by 5-inch aluminum panel between the electrodes in the electrostatic test unit so that the detector head is directly in the center of the panel. Tighten the four wing nuts to secure the panel.
- 6.1.5 Set speed of the data capture to 60 readings/min. Start data capture.
- 6.1.6 Set "operate" switch on the electrometer to "operate."
- 6.1.7 Turn three-position control switch to high voltage.
- 6.1.8 Observe that the reading on the recorder is identical with the measurement on the meter. Adjust the recorder if necessary.
- 6.1.9 Turn three-position control switch to ground to remove the charge from the test panel.
- 6.1.10 When the electrometer meter reaches zero, stop the recorder and turn the "operate" switch on the electrometer to "zero check."
- 6.1.11 Repeat the calibration procedure for 5 KV negative. Set the appropriate controls on the apparatus for negative charge.

6.2 TEST

- 6.2.1 Each specimen, when tested, shall be mounted vertically between the electrodes and the wing nuts tightened to insure intimate contact between specimen and electrodes.
- 6.2.2 Set data capture speed to 30 readings/second and start data capture.

- 6.2.3 Set electrometer meter switch to indicate positive or negative charge, depending on the high voltage to be applied.
- 6.2.4 Adjust the high voltage for the desired 5 KV potential.
- 6.2.5 Set "operate" switch on electrometer to "operate."
- 6.2.6 Turn the three—position control switch to high voltage.
- 6.2.7 When the meter indication stops increasing, indicating the specimen has received its maximum charge, turn the three-position switch to ground position.
- 6.2.8 When the meter needle reaches zero or after ten seconds, whichever comes first, stop data capture and move "operate" switch to "zero check."
- 6.2.9 Charge each specimen three times for both positive and negative charges, allowing specimen to remain grounded for ten minutes after each charging cycle to remove any residual charge on the specimen. For nonhomogeneous materials, both surfaces shall be charged by reversing the face of the material in contact with the inner electrodes.
- 6.2.10 Calculate charge decay time by measuring the horizontal distance on the chart from the point where the specimen was grounded to the point where the needle reached zero. With the speed of data capture known, calculate the decay time for each specimen in seconds.

7. REPORT

- 7.1 Report the facts pertinent to the test.
 - 7.1.1 State that the test was conducted in accordance with this procedure or describe any deviations.
 - 7.1.2 Identify the specimen and specific material tested.
 - 7.1.3 Results of test.
 - 7.1.3.1 State the decay time for each specimen for both positive and negative charges, as calculated in 6.2.10.
 - 7.1.3.2 State that material was tested as received, aged, and after exposure to shower. Also state which surface was charged.

8. NOTES

- 8.1 The purpose of this procedure is to evaluate the electrostatic buildup and dissipation properties of packaging materials used to protect components and electronic parts that are susceptible to damage by electrostatic discharge.
- 8.2 The Keithley 621 Electrometer may be used. Other settings may apply if another suitable electrometer of different design is used.

APPENDIX B – NFPA Code 99

National Fire Protection Association (NFPA)

Code 99 – Standard for Health Care Facilities (1993):

Paragraph 12-4.1.3.8 Reduction in Electrostatic Hazard

Paragraph 4663

Antistatic sheeting, film and textiles shall meet the specific requirements of at least one of the following test methods when preconditioned at 50%, $\pm 2\%$ RH at $70^{\circ} \pm 3.5^{\circ}\text{F}$ for 25 hours or until equilibrium is reached, and tested at 50% $\pm 2\%$ RH at $70^{\circ} \pm 3.5^{\circ}\text{F}$.

1. Method 4046 of Federal Test Method Standard 101C. After the specimen has received its maximum charge from the application of 5000 volts, the time for the indicated specimen potential to drop to 10% of its maximum value shall not exceed $\frac{1}{2}$ second.

Note: The static detector head should be of a type that is adequately shielded to minimize responses to potentials on the electrodes and other stray pickup.

Paragraph 4664

Antistatic items other than sheeting, film and textiles shall be tested in a manner as closely as possible equivalent to that given in 4663.

APPENDIX C - MIL-PRF-81705D

Mil-PRF-81705D, – Barrier Materials, Flexible, Electrostatic Protective, Heat Sealable. (Applicable sections)

1.0 Scope

1.1 This specification covers opaque and transparent heat sealable, electrostatic free, flexible, barrier materials for the packaging of missiles, explosive powered and electro-sensitive devices, micro-circuits, semiconductors, thin film resistors, and associated airborne components.

Table 1: Electrostatic properties:

The decay rate shall be 2.00 seconds (maximum) re: Paragraph 4.8.3.

4.0 Quality Assurance Provisions

4.8.3. The tests indicated below shall be conducted in accordance with the specified methods of Fed. Test Method Std. 3010, Electrostatic Properties – Method 4046 per Note 7.

Note 7: Preparation of the test specimens shall be as follows:

Five 3 by 5 inch specimens shall be selected from the material to be tested, one from each outside edge and one from the center. Six additional specimens shall be cut from the same areas. Three shall be aged by exposing the specimen to a dry atmosphere at 160° F for 12 consecutive days. The remaining three shall be placed under a shower in a horizontal position for a minimum of 24 hours. All specimens shall then be placed in the drying chamber for 24 hours before testing. Report the average for the five specimens for As Received, Aged and After Shower Exposure to the nearest 0.01 second.

APPENDIX D - 4406 Controls and Connections

FRONT PANEL KEYBOARD

A 2-section, 20-button keyboard utilizing replaceable long life, light-touch pushbuttons are used to control all functions.

The 12-button section is used to program the Analyzer Functions of **Static Decay** (System currently limited to performing Static Decay test only), Charge Plate (**CHG PLATE**), and Charge Retention (**CHG RETEN**) [Future optional features.], manual or auto (**MAN/AUTO**) operation, high voltage polarity (**V +/-**) voltage ON/OFF (**V ON/OFF**) and **CUTOFF** select levels of **1%**, **10%** or user adjustable (**CUTOFF ADJ**) from 1-50%. Escape (**ESC**) enables the user to exit a test in progress.

The 8-button section controls the measurement of the function selected (currently only Static Decay). These are programming the ± 600 -5,000V HVPS (**PROG V**), Auto function settings (**AUTO FUNC SET**), system operation check (**SYS CHECK**), data analysis/export data (**DATA ANAL/EXP**) [future export capability] standby status (**ZERO/STBY**), measurements pertaining to the measurement of charge (**CHG**), measurements pertaining to the measurement of static decay time (**DECAY TEST**) and retesting the last measurement or sequence (**RETEST PREV**).

ZERO/STBY

The Analyzer defaults to the **ZERO/STBY** mode when the instrument is turned on. The display shows the state of each function the system was in prior to shut down. Figure 2.2-2 is a typical example.

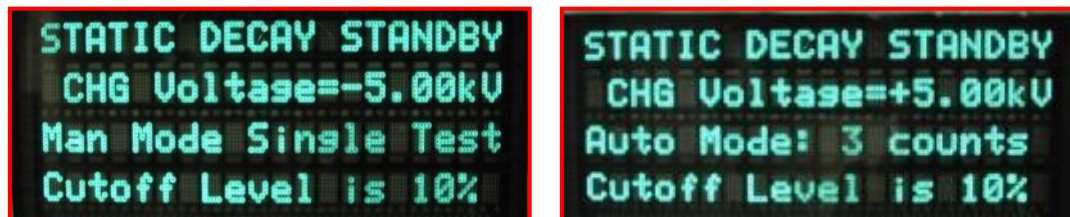

Figure 2.2-2: Static decay display in ZERO/STBY mode

When the **ZERO/STBY** key is depressed during testing the system goes into the Standby mode and the current settings displayed. In this state, the status of the High Voltage Power Supply is displayed, the electrostatic sensor shutter in the Faraday Cage is closed, and the operating mode (**MAN/AUTO**) and **CUTOFF** level selected are displayed.

Depressing the **ZEROSTBY** key will start a new test.

SYSTEM CHECK

This key performs a system test using the **STM-2** System Test Module. This Module has a fixed decay time and simulates a test sample when charged to 5.00kV and then grounded. The decay time to both the 10% and 1% cutoff levels are displayed individually and then the average + and average – decay times are displayed as shown in Figure 2.2-3.

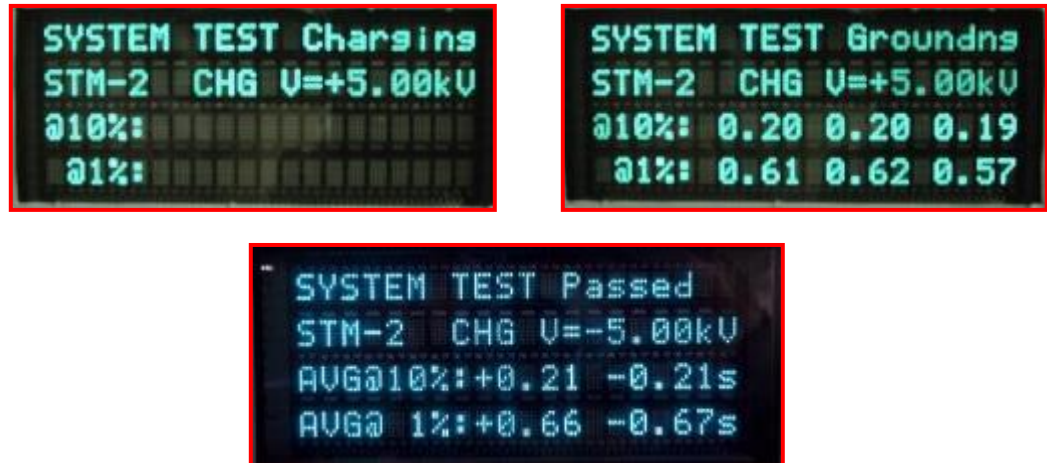

Figure 2.2-3: System Test Display

CHARGE

This key controls all charging measurements. The charge function is used to check the initial static dissipative characteristics of the material under test. When depressed, any Initial Charge (**IC**) on the sample will first be displayed and then the high voltage will be applied. If the sample begins to charge at the rate of at least 250V/sec the sample will continue to charge for up to 60 sec. At that point the ability of the material to accept a conducted charge (**AC**) will be displayed. The more charge conducted the more dissipative the material. This technique is used to evaluate material that is on the border of being somewhat dissipative and insulative.

If the sample is static dissipative the charging of the sample must indicate at least 3.00-5.00kV and stabilize for 5 seconds before a static decay test can be performed. The 3.00kV is chosen since standard “dog bone” test plaques will indicate approximately **AC=3.75kV** when fully charged to 5.00kV. This effect is caused by the electrostatic field sensor detecting a field smaller than the one associated with a 3.5x3.5” (89x144mm) sample. Other non-planar sample shapes will also cause the **AC=** to read lower or even higher such as the bubble side of bubble wrap.

Figure 2.2-4a shows the **CHARGE** display for a non-static dissipative sample and Figures 2.2-4b & c for a sample with static dissipation characteristics for testing in the **Manual** mode.

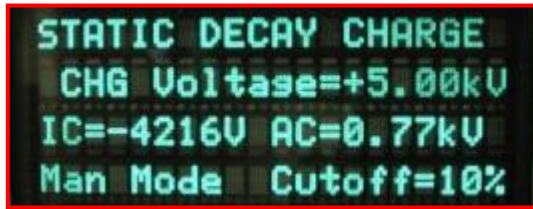

a. Non-dissipative sample

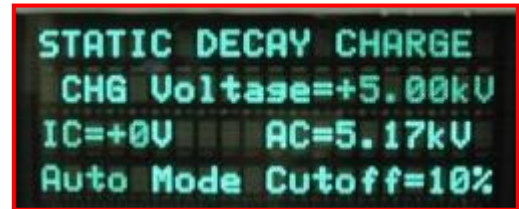

b. Dissipative sample

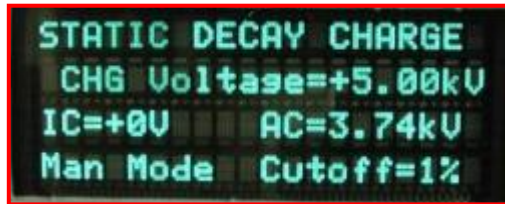

c. Dissipative undersize ("dog bone") sample

Figure 2.2-4: Static decay display in **CHARGE** mode

DECAY TEST

This key controls all static decay time measurements. Static decay time is measured to the selected cutoff each time the **DECAY TEST** key is depressed in the **MAN** mode. The High Voltage is applied to the sample holder electrodes and the shutter in the electrostatic sensor is opens (audible click). The sample begins to conduct charge across its surface and when it reaches the maximum indicated accepted charge (5.00kV applied is defaulted in the **AUTO** mode and is adjustable by the user in **MAN** mode) and stabilizes for 5 seconds (must be at least 3.00kV), the charge relay then opens and the ground relay closes. The sensor shutter remains open until the charge on the sample decays down and crosses the cutoff level at which time the static decay time is measured and displayed, then the sensor shutter closes. The ground relay remains closed until the next test cycle is initiated.

If the sample cannot charge to greater than 3.00kV the display shows "**Sample can't reach FS**" as shown in Figure 2.2-5.

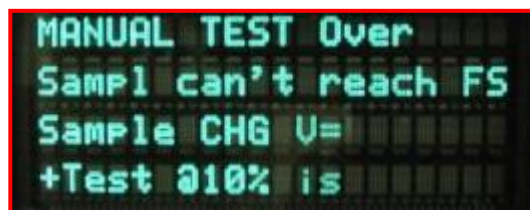

Figure 2.2-5: Display of sample that does not accept charge

MAN mode: A single decay time measurement is made and displayed each time the Decay Time key is depressed as shown in Figure 2.2-6.

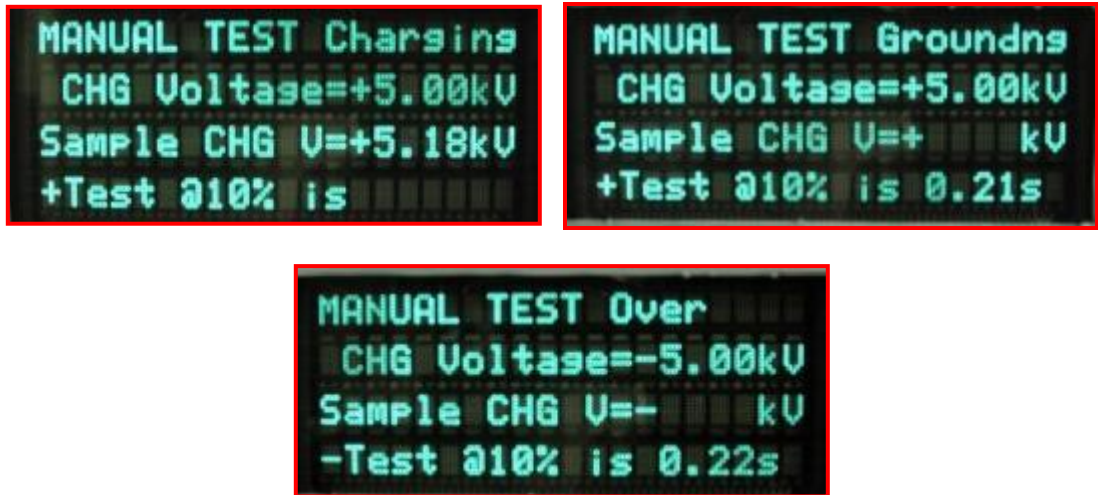

Figure 2.2-6: **MAN**ual mode decay time measurement

AUTO mode: Depressing the **DECAY TEST** key will start a static decay time measurement sequence that is defaulted to 3 measurements at each polarity, however, up to 6 measurements each can be programmed. The test sequence always starts at +5.00kV and then switches -5.00kV. At 3 measurements both + and - are displayed. More than 3 only the last 3 measurements will be displayed. Each time the key is depressed another decay time sequence (on the same or new sample) will be measured and displayed as shown in Figure 2.2-7.

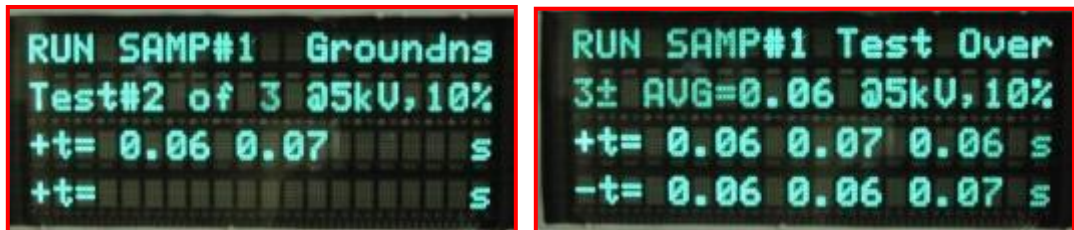

Figure 2.2-7: **AUTO** mode decay time measurement

To select the number of measurements to be taken depress the **AUTO FUNC SET** key. The display will appear as in Figure 2.2-8.



Figure 2.2-8: **AUTO** mode counts setting

RETEST

This key retests the prior measurement in the **AUTO** mode only.

To stop the test sequence and hold the last measurement the **ESC** button on the 12-button keypad is depressed. Depressing the **RETEST** button retests the prior measurement (ex: if Hold at 3, **RETEST** will be 2). Depressing the **DECAY TEST** button will continue the test cycle from where it was held.

DATA ANAL/EXP

The **DATA ANAL**ysis feature calculates the **Min**, **Max** and **Average** for each test sequence in the **AUTO** mode for the cutoff level selected as shown in Figure 2.2-9.

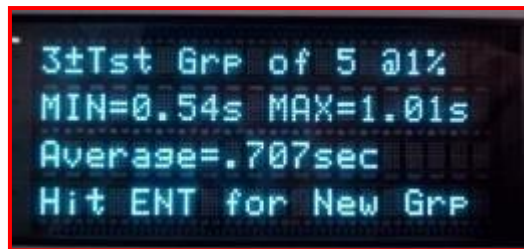

Figure 2.2-9: Data analysis display

EXPORT

The **EXPORT** feature will export only the group results from the **AUTO** mode tests through RS-232 communication to a (user provided) host PC. The Hyper Terminal program in the PC will collect the data as shown in Figure 2.2-10.

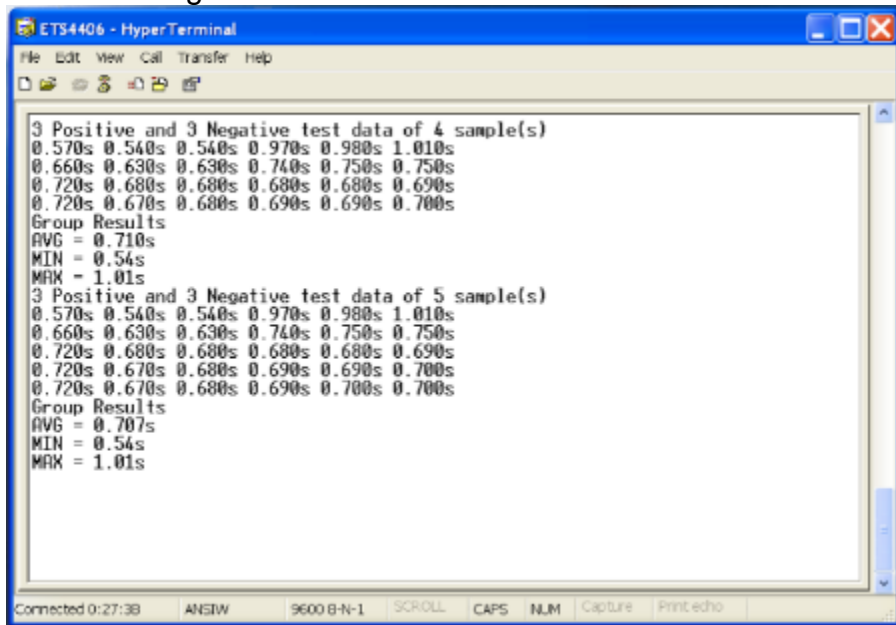

Figure 2.2-10: Data export computer screen

PROG V

When this key is depressed the Charging Voltage level can be programmed anywhere from 600-5,500V with 10V resolution and is so indicated on the display.

V +/-

Each time this key is depressed the polarity of the HVPS switches from + to - or from - to +.

V ON/OFF

Each time this key is depressed the HVPS is turned **OFF** and **ON**. The status of the voltage is displayed and indicated by both the display and with a red LED.

CUTOFF Threshold Selection: 1%, 10%, or ADJutable

These 3 keys are used to select the decay time measurement **CUTOFF** threshold. Three cutoff thresholds are provided: **1%** (per Mil-PRF-81705E, EIA and ESD 541), **10%** (per NFPA 99) and an **Adjustable** cutoff that can be programmed from 50-1%. (**NOTE:** Static decay testing using the Method 4046 type test method restricts the measurement cutoff to a decay time cutoff no shorter than 50% of the indicated accepted charge)

For those applications where testing to CECC 00015 Section 8.2 is required, the cutoff should be programmed to 5%. This test is performed at $\pm 1,000V$. The system Full Scale calibration will have to be readjusted so the **AC=** reads at least 3.00kV.

System Function Keys: STATIC DECAY, CHG PLATE, CHG RET

These keys select the electrostatic measurement function of the Analyzer. Currently only the **STATIC DECAY** per Method 4046 can be selected. **CHG PLATE** and **CHG RET** functions are currently not available, and are reserved for future options. When these keys are depressed, the display will read "NOT FUNCTION".

AUTO/MAN, AUTO FUNC SET

AUTO/MAN Selects the **AUTO** or **MAN**ual Static Decay measurement modes.

The **AUTO FUNC SET** key brings up the menu for programming the number of measurements (counts, up to 6) in the **AUTO** mode. This is functional only when **Static Decay** is selected. The interval between measurements (time ground relay remains closed before the next test is initiated) is automatically determined.

Rear Panel

Figure 2.4-1 shows the rear panel of the Model 4406 Control Unit. All input/output connections are made from the rear panel.

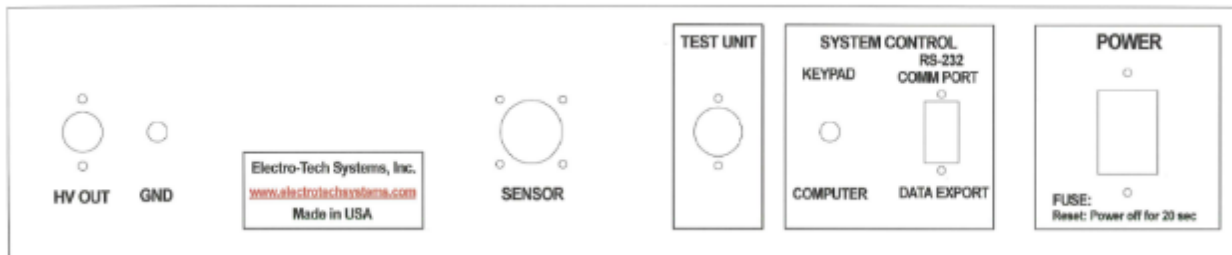

KEYPAD/COMPUTER toggle switch.

This toggle switch is currently **NOT IN USE**.

SENSOR

The cable from the electrostatic sensor plugs into this connector.

TEST UNIT

This 7-pin DIN connector provides the control signal interface between the **Faraday Cage** used to perform the Static Decay test and the **Control unit**.

When the **Charged Plate Analyzer** and **Charge Retention** features are added the respective Test Units will interface with the Control unit via this connector.

COMM PORT

The **COMM PORT** is a 9-pin (D-sub, or DB9) connector that enables the instrument to be connected to a computer for receiving static decay **AUTO** mode data, using the ETS provided communication cable. Three pins are used, following standard rs-232 conventions. The connections for the 9-pin connector are as follows:

Pin – 1:	N/C
Pin – 2:	Tx
Pin – 3:	Rx
Pin – 4:	N/C
Pin – 5:	GND
Pin – 6:	N/C
Pin – 7:	N/C
Pin – 8:	N/C
Pin – 9:	N/C

APPENDIX E - Electrode Configurations

Caution: Make sure the length of the sample does not touch the cage cover when closed. This will cause the electrodes to short to the grounded cage and result in no voltage being applied to the sample.

7.1 Magnetic Electrodes

Magnetic Electrodes are used to secure film and fabric samples plus the **STM-2** to the base electrodes as shown in Figure 7-1.

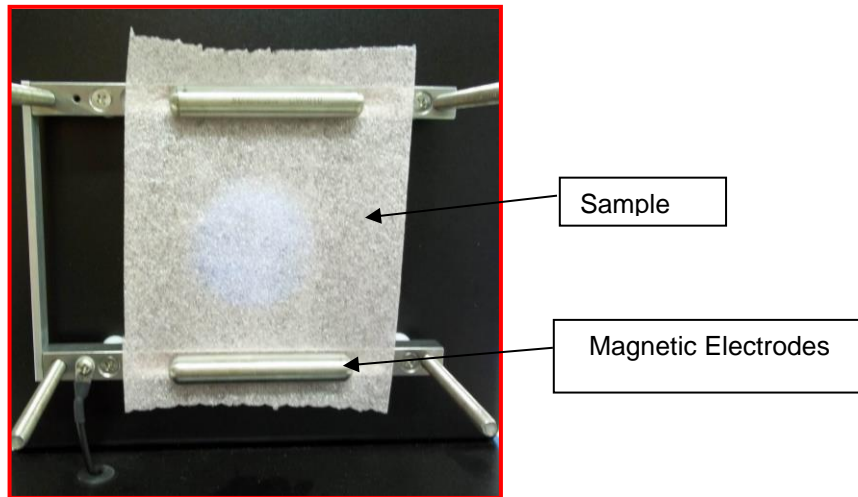
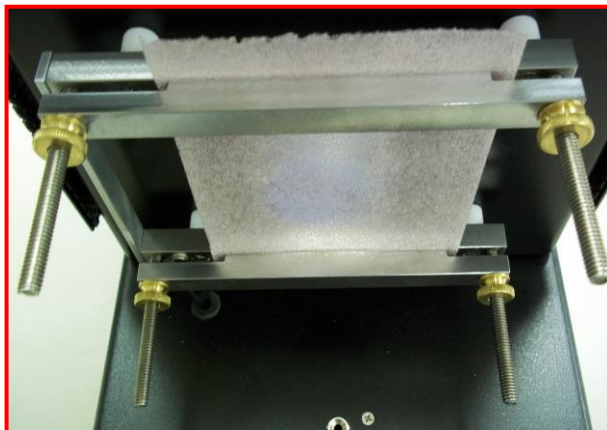

Figure 7-1: Magnetic Electrodes

7.2 Clamp Electrodes

Clamp Electrodes, for planar and “dog bone” samples, shown in Figure 7-2a and b are used to secure samples that are up to one inch thick. Thicker samples can be tested using longer ¼-20 threaded rods.



a. Planar sample

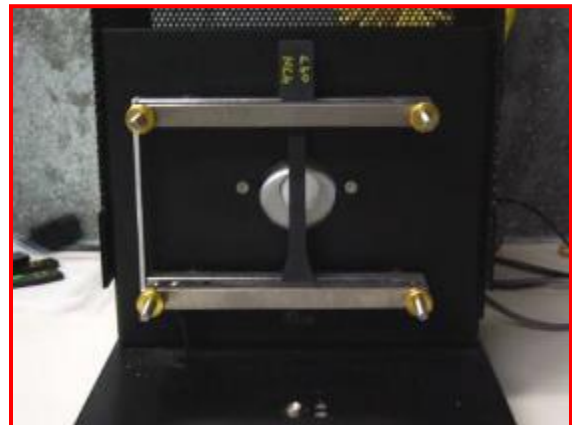

b. “Dog bone sample

Figure 7-2: Clamp Electrodes

7.3 Loose Fill Electrodes

Loose Fill Electrodes are used to test loose fill packing chips. Six chips are needed for each test sample array. The chips must be placed over the electrode points and rest on the shoulder as shown in Figure 7-3. This is necessary in order to make contact with the outer surface of the chip so that surface treated material will be properly tested.

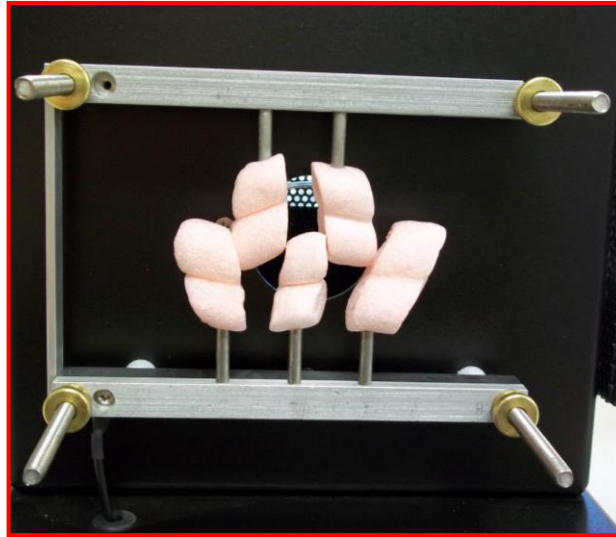

Figure 7-3: Loose Fill Electrodes

7.4 I.C. Electrodes

When using the I.C. Tube Electrodes, remove the outer clamp electrodes from the fixture. Adjust the tension on the outer I.C. Tube Electrode so that the size tube to be tested slides easily through the roller contacts. To test a tube, place it through the hole located on the side of the cage (Must be installed at time of order) and slide it through as shown in Figure 7-4.

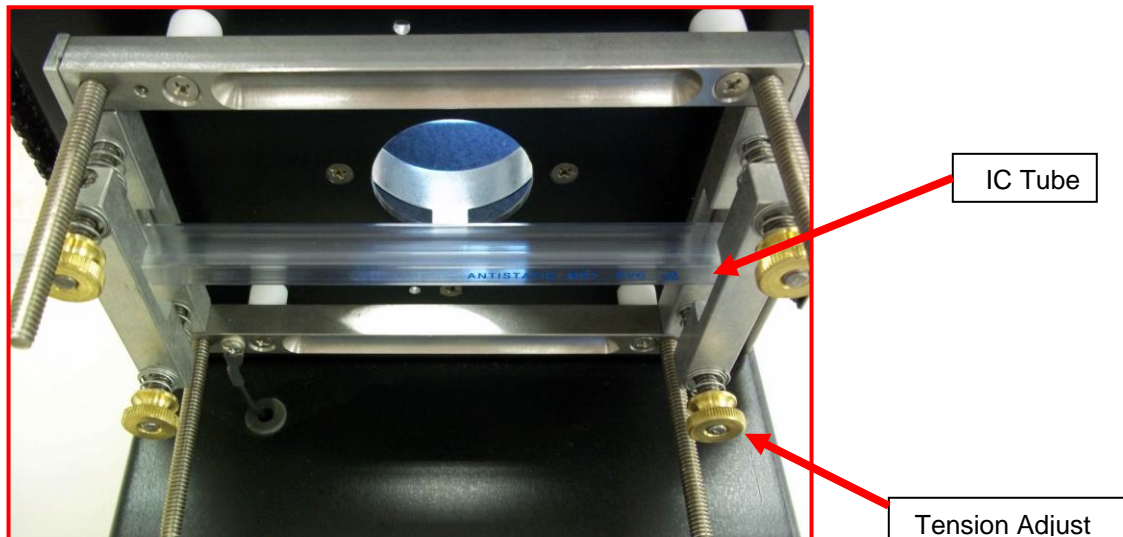

Figure 7-4: I.C. Shipping Tube Electrodes

7.5 Small Sample Electrodes

The standard ETS Model 4406 Static Decay Analyzer is designed to test film, fabric and rigid samples having a nominal size of 3.5" x 5.5" (80 x 144mm). However, the electrodes can accommodate a flexible sample size down to 4.125" (105mm) in length. The electrodes are electrically connected together. The dual electrode configuration is required to secure thin films and fabrics. For rigid samples, just the bottom electrode configuration can be used.

However, to test undersize flexible samples that are <4.125" (105mm) long a special electrode configuration is required to hold the sample and bring it within view of the sensor. To install, first remove the magnetic or clamp electrodes, if installed. Place the .25" (6mm) slots over the threaded rods and secure with the thumbscrews or wing nuts. If a small rigid sample is being tested then only the bottom electrode needs to be installed. If film or fabric samples are to be tested then both upper and lower electrodes are required as shown in Figure 7-5a and b respectively. The sample holders each can be adjusted vertically up to 0.5" (12mm). This allows for minimum sample lengths from 2.5" to 3.5" (63-89mm).

These electrodes come with both aluminum and Delrin clamps in case it is desired to isolate the rear of the sample.

The Full Scale Calibration of the sensor must be performed as described in Section V-2, and then tested in the standard manner. NOTE: The field effect using these electrodes will be greater than the nominal 1,500V seen with the standard electrodes. Use a known conductive or dissipative sample to perform this set-up. When recalibrated the indicated charge (AC=) on the sample MUST be at least 3.00kV.

Otherwise, contact the factory for other special configurations.

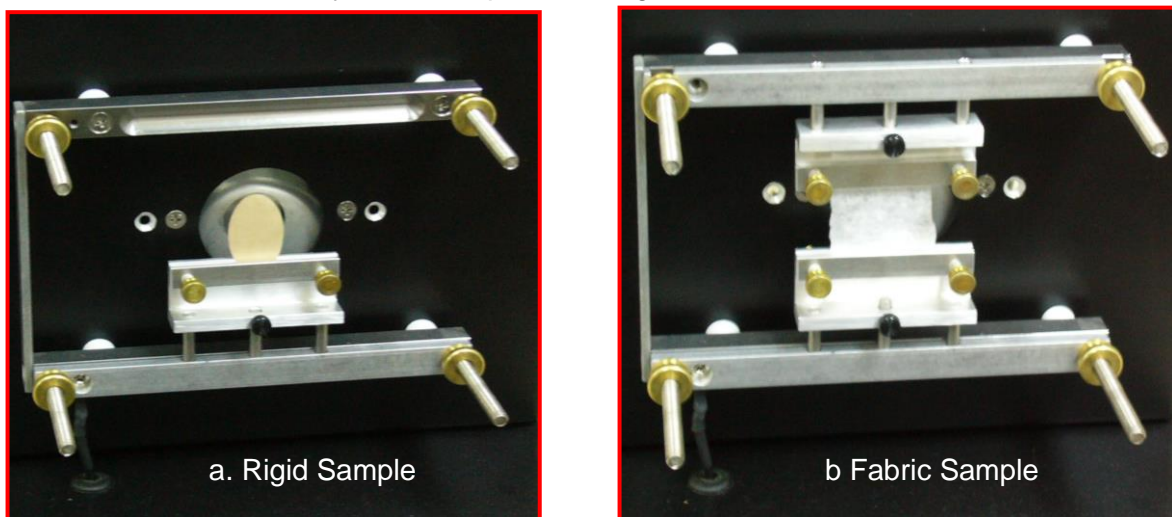

Figure 7-5: Small Sample Electrode.